

Bayesian Statistical Model Checking

E.M. Clarke, A. Platzer, **P. Zuliani**

School of Computer Science
Carnegie Mellon University



```
++CDatabase::_stats.mem_used_u
_params.max_unrelevance = (int
if (_params.max_unrelevance <
_params.max_unrelevance =
_params.min_num_clause_lits fo
if (_params.min_num_clause_lit
_params.min_num_clause_lit
_params.max_num_clause_le
if (_params.max_conflict_claus
_params.max_conflict_claus
CHECK(
cout << "Forced to reduce unre
cout << "MaxUnrel: " << _params
    << "  MinLenDel: " << _pa
    << "  MaxLenCL : " << _pa
);
```

Problem

Verification of Stochastic Systems

- **Uncertainties** in the system environment, modeling a fault, stochastic processors, biological signaling pathways ...
 - Modeling uncertainty with a distribution → Stochastic systems
- **Models:**
 - for example, Discrete, Continuous Time Markov Chains
- **Property specification:**
 - “does the system fulfill a request within 1.2 ms with probability at least .99”?
- If ϕ = “system fulfills request within 1.2 ms”, **decide** between:

$$P_{\geq .99}(\phi) \text{ or } P_{< .99}(\phi)$$

Equivalently

- A biased coin (**Bernoulli random variable**):
 - Prob (Head) = p Prob (Tail) = $1-p$
 - p is **unknown**
- Question: Is $p \geq \theta$? (for a fixed $0 < \theta < 1$)
- A solution: **flip the coin** a number of times, **collect the outcomes**, and use:
 - Statistical **hypothesis testing**: returns *yes/no*
 - Statistical **estimation**: returns “ p in (a,b) ” (and compare a with θ)

Statistical Model Checking

Key idea

- Suppose system behavior w.r.t. a (fixed) property Φ can be modeled by a Bernoulli random variable of parameter p :
 - System satisfies Φ with (unknown) probability p
- Questions: $P_{\geq\theta}(\Phi)$? (for a fixed $0 < \theta < 1$)
- Draw a sample of system simulations and use:
 - Statistical hypothesis testing: Null vs. Alternative hypothesis
$$H_0 : \mathcal{M} \models P_{\geq\theta}(\phi) \quad H_1 : \mathcal{M} \models P_{<\theta}(\phi)$$
- Statistical estimation: returns “ p in (a,b) ” (and compare a with θ)

Motivation

- **State Space Exploration** infeasible for large systems
 - Symbolic MC with OBDDs scales to 10^{300} states
 - Scalability depends on the structure of the system
- **Pros: Simulation** is feasible for **many more** systems
 - Often easier to **simulate** a complex system than to **build the transition relation** for it
 - Easier to **parallelize**
- **Cons:** answers may be **wrong**
 - But error probability can be **bounded**

Bayesian Statistical Model Checking

- We have developed a **new** MC algorithm
 - Statistical Model Checking Algorithm
 - Sequential sampling
 - Performs Hypothesis Testing (and Estimation)
 - Based on **Bayes Theorem**

- ❑ *S. K. Jha, E. M. Clarke, C. J. Langmead, A. Legay, A. Platzer, P. Zuliani. CMSB 2009.*
- ❑ *P. Zuliani, A. Platzer, E. M. Clarke. HSCC 2010.*

Bayesian Statistics

Three ingredients

1. Prior probability:

- Models our initial uncertainty/belief about parameters (what is $\text{Prob}(p \geq \theta)$?)

2. Likelihood function:

- Describes the distribution of data (e.g., a sequence of heads/tails), given a specific parameter value

3. Bayes Theorem:

- Revises uncertainty upon experimental data - compute $\text{Prob}(p \geq \theta \mid \text{data})$

Bounded Linear Temporal Logic

- **Bounded Linear Temporal Logic (BLTL)**: Extension of LTL with **time bounds** on temporal operators.
- Let $\sigma = (s_0, t_0), (s_1, t_1), \dots$ be an execution of the model
 - along states s_0, s_1, \dots
 - the system stays in state s_i for time t_i
 - **divergence of time**: $\sum_i t_i$ diverges (i.e., non-zero)
- σ^i : Execution trace starting at state i .
- $V(\sigma, i, x)$: Value of the variable x at the state s_i in σ .
- A model for simulation traces (e.g. Simulink, BioNetGen)

Semantics of BLTL

The semantics of BLTL for a trace σ^k :

- $\sigma^k \models x \sim c$ iff $V(\sigma, k, x) \sim c$, where \sim is in $\{\leq, \geq, =\}$
- $\sigma^k \models \Phi_1 \vee \Phi_2$ iff $\sigma^k \models \Phi_1$ or $\sigma^k \models \Phi_2$
- $\sigma^k \models \neg\Phi$ iff $\sigma^k \models \Phi$ does not hold
- $\sigma^k \models \Phi_1 \mathcal{U}^t \Phi_2$ iff there exists natural i such that
 - 1) $\sigma^{k+i} \models \Phi_2$
 - 2) $\sum_{j < i} t_{k+j} \leq t$
 - 3) for each $0 \leq j < i$, $\sigma^{k+j} \models \Phi_1$

“within time t , Φ_2 will be true and Φ_1 will hold until then”

- In particular, $F^t \Phi = \text{true} \mathcal{U}^t \Phi$, $G^t \Phi = \neg F^t \neg\Phi$

Semantics of BLTL (cont'd)

- Simulation traces are finite: is $\sigma \models \Phi$ well defined?

- Definition: The time bound of Φ :

- $\#(x \sim c) = 0$
- $\#(\neg\Phi) = \#(\Phi)$
- $\#(\Phi_1 \vee \Phi_2) = \max(\#(\Phi_1), \#(\Phi_2))$
- $\#(\Phi_1 \mathcal{U}^t \Phi_2) = t + \max(\#(\Phi_1), \#(\Phi_2))$

- Lemma: “Bounded simulations suffice”

Let Φ be a BLTL property, and $k \geq 0$. For any two infinite traces ρ, σ such that ρ^k and σ^k “equal up to time $\#(\Phi)$ ” we have

$$\rho^k \models \Phi \quad \text{iff} \quad \sigma^k \models \Phi$$

Sequential Bayesian Statistical MC - I

- Model Checking $H_0 : \mathcal{M} \models P_{\geq \theta}(\phi)$ $H_1 : \mathcal{M} \models P_{< \theta}(\phi)$
- Suppose \mathcal{M} satisfies ϕ with (unknown) probability p
 - p is given by a random variable U (defined on $[0,1]$) with density g
 - g represents the prior belief that \mathcal{M} satisfies ϕ
- Generate independent and identically distributed (iid) sample traces.
- x_i : the i^{th} sample trace σ satisfies ϕ
 - $x_i = 1$ iff $\sigma_i \models \phi$
 - $x_i = 0$ iff $\sigma_i \not\models \phi$
- Then, x_i will be a Bernoulli trial with conditional density (likelihood function)

$$f(x_i|u) = u^{x_i}(1 - u)^{1-x_i}$$

Sequential Bayesian Statistical MC - II

- $X = (x_1, \dots, x_n)$ a sample of Bernoulli random variables
- **Prior probabilities** $P(H_0)$, $P(H_1)$ strictly positive, sum to 1
- **Posterior probability** (**Bayes Theorem** [1763])

$$P(H_0|X) = \frac{P(X|H_0)P(H_0)}{P(X)}$$

for $P(X) > 0$

- **Ratio of Posterior Probabilities:**

$$\frac{P(H_0|X)}{P(H_1|X)} = \frac{P(X|H_0)}{P(X|H_1)} \cdot \frac{P(H_0)}{P(H_1)}$$

Bayes Factor

Sequential Bayesian Statistical MC - III

- Recall the Bayes factor $B = \frac{P(X|H_0)}{P(X|H_1)}$
- Jeffreys' [1960s] suggested the Bayes factor as a statistic:
 - For fixed sample sizes
 - For example, a Bayes factor greater than 100 “strongly supports” H_0
- We introduce a sequential version of Jeffrey's test
- Fix **threshold** $T \geq 1$ and prior probability.
Continue sampling until
 - Bayes Factor $> T$: **Accept** H_0
 - Bayes Factor $< 1/T$: **Reject** H_0

Sequential Bayesian Statistical MC - IV

Require: *Property $P_{\geq\theta}(\Phi)$, Threshold $T \geq 1$, Prior density g*

$n := 0$ *{number of traces drawn so far}*

$s := 0$ *{number of traces satisfying Φ so far}*

repeat

$\sigma :=$ draw a sample trace of the system (iid)

$n := n + 1$

if $\sigma \models \Phi$ **then**

$s := s + 1$

endif

$\mathcal{B} := \text{BayesFactor}(n, s, g)$

until $(\mathcal{B} > T \vee \mathcal{B} < 1/T)$

if $(\mathcal{B} > T)$ **then**

return H_0 *accepted*

else

return H_0 *rejected*

endif

Sequential Bayesian Statistical MC - V

- The Bayes Factor uses posterior (and prior) probability

$$\frac{P(X|H_0)}{P(X|H_1)} = \frac{P(H_0|X)}{P(H_1|X)} \cdot \frac{P(H_1)}{P(H_0)}$$

- Bayes Factor: Measure of confidence in H_0 vs H_1
 - provided by the data $X = (x_1, \dots, x_n)$
 - “weighted” by the prior probabilities
- Posterior density (Bayes Theorem) (iid Bernoulli samples)

Likelihood function

$$f(u | x_1, \dots, x_n) = \frac{f(x_1 | u) \cdots f(x_n | u) \cdot g(u)}{\int_0^1 f(x_1 | v) \cdots f(x_n | v) \cdot g(v) dv}$$

Sequential Bayesian Statistical MC - VI

Definition: Bayes Factor \mathcal{B} of sample X and hypotheses H_0, H_1

joint (conditional) density of
independent samples

$$B = \frac{P(X|H_0)}{P(X|H_1)} = \frac{1-\pi_0}{\pi_0} \cdot \frac{\int_{\theta}^1 \overbrace{f(x_1|u) \cdots f(x_n|u)}^{\text{joint (conditional) density of independent samples}} \cdot g(u) \, du}{\int_0^{\theta} f(x_1|u) \cdots f(x_n|u) \cdot g(u) \, du}$$

- $\pi_0 = P(H_0) = \int_{\theta}^1 g(u) \, du$ prior g is Beta of parameters $\alpha > 0, \beta > 0$

$$g(u) = \frac{1}{B(\alpha, \beta)} u^{\alpha-1} (1-u)^{\beta-1}$$

$$B(\alpha, \beta) = \int_0^1 t^{\alpha-1} (1-t)^{\beta-1} \, dt$$

Why Beta priors?

- Defined over $[0,1]$
- Beta distributions are *conjugate* to Binomial distributions:
 - If prior g is Beta and likelihood function is Binomial then *posterior is Beta*
- Suppose likelihood Binomial(n,x), prior Beta(α,β): posterior

$$\begin{aligned}f(u \mid x_1, \dots, x_n) &\approx f(x_1|u) \cdot \dots \cdot f(x_n|u) \cdot g(u) \\ &= u^x(1-u)^{n-x} \cdot u^{\alpha-1}(1-u)^{\beta-1} \\ &= u^{x+\alpha-1}(1-u)^{n-x+\beta-1}\end{aligned}$$

where $x = \sum_i x_i$

- Posterior is Beta of parameters $x+\alpha$ and $n-x+\beta$

Beta Density Shapes

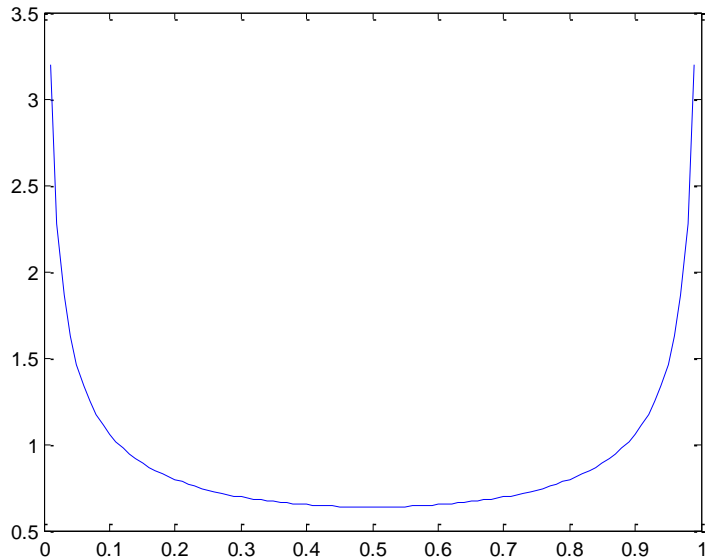

$\alpha=0.5$ $\beta=0.5$

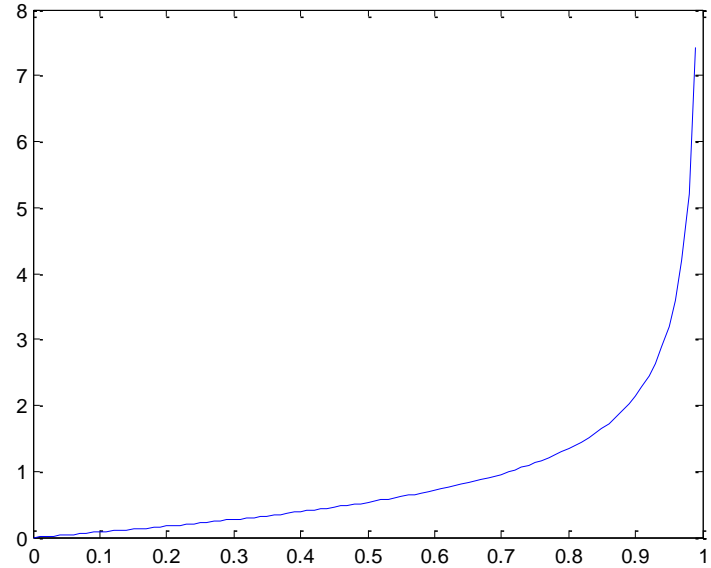

$\alpha=2$ $\beta=0.5$

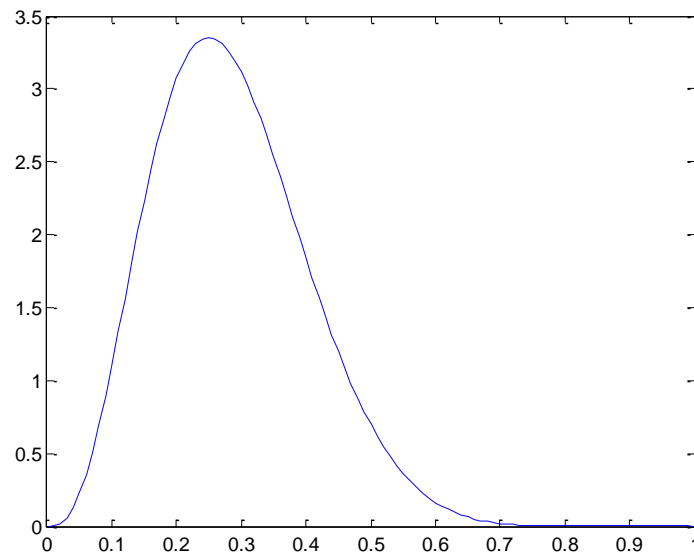

$\alpha=4$ $\beta=10$

Computing the Bayes Factor

Proposition

The Bayes factor of $H_0: \mathcal{M} \models P_{\geq \theta}(\Phi)$ vs $H_1: \mathcal{M} \models P_{< \theta}(\Phi)$ for n Bernoulli samples (with $x \leq n$ successes) and prior $\text{Beta}(\alpha, \beta)$

$$B = \frac{1 - \pi_0}{\pi_0} \cdot \left(\frac{1}{F_{(x+\alpha, n-x+\beta)}(\theta)} - 1 \right)$$

where $F_{(s,t)}(\cdot)$ is the Beta distribution function of parameters s, t .

- No need of integration when computing the Bayes factor

Sequential Bayesian Statistical MC - VII

Theorem (Termination). The Sequential Bayesian Statistical MC algorithm **terminates with probability one**.

Theorem (Error bounds). When the Bayesian algorithm – using threshold T – stops, the following holds:

$$\text{Prob ("accept } H_0" \mid H_1) \leq 1/T$$

$$\text{Prob ("reject } H_0" \mid H_0) \leq 1/T$$

Note: bounds independent from the prior distribution.

Fuel Control System - I

The Simulink model:

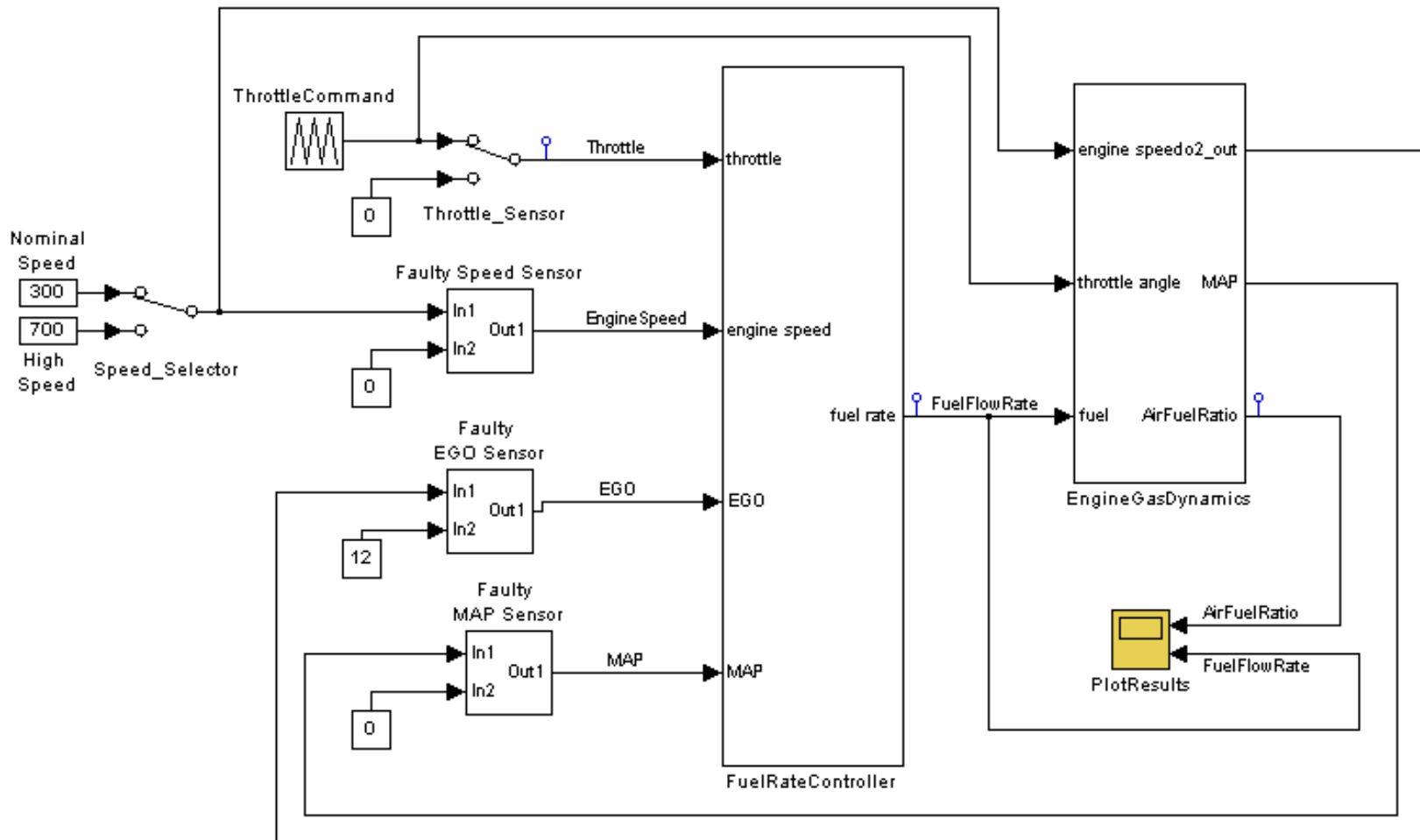

Fuel Control System - II

- Ratio between **air mass flow** rate and **fuel mass flow** rate
 - Stoichiometric ratio is 14.6
- Senses amount of oxygen in exhaust gas, pressure, engine speed and throttle to **compute correct fuel rate**.
 - **Single sensor faults are compensated** by switching to a higher oxygen content mixture.
 - Multiple sensor faults **force engine shutdown**.

Fuel Control System - III

- **Stateflow** part of the model has **24 locations**
 - grouped in 6 simultaneously active states
- **Simulink** part of the model is rich
 - **Several nonlinear equations**
 - Linear ODE
- Probabilistic behavior because of **random faults**
 - in the EGO (oxygen), pressure and speed sensors.
 - Faults modeled by three independent Poisson processes
 - We did not change the speed or throttle inputs.

Fuel Control System - IV

- We Model Check the formula (**Null hypothesis**)

$$\mathcal{M}, \text{FaultRate} \models P_{\geq \theta} (\neg \mathbf{F}^{100} \mathbf{G}^1(\text{FuelFlowRate} = 0))$$

for $\theta = .5, .7, .8, .9, .99$

- *“It is not the case that within 100 seconds, FuelFlowRate is zero for 1 second”*
- We use various values of *FaultRate* for each of the three sensors in the model
- We choose **Bayes threshold** $T = 1000$, i.e., stop when probability of error is $< .001$
- Uniform, equally likely priors and “informative” priors

Fuel Control System: results

Recall the **Null hypothesis**:

$$\mathcal{M}, \text{FaultRate} \models P_{\geq \theta} (\neg \mathbf{F}^{100} \mathbf{G}^1 (\text{FuelFlowRate} = 0))$$

Priors: *uniform, equally likely.*

Number of samples and test decision:

- **red / blue** number: **reject / accept** null hypothesis

		Probability threshold θ				
		.5	.7	.8	.9	.99
Fault rates	[3 7 8]	58	17	10	8	2
	[10 8 9]	32	95	394	710	8
	[20 10 20]	9	16	24	44	1,626
	[30 30 30]	9	16	24	44	239

Longest run: 1h 5' on a 2.4GHz Pentium 4 computer

Fuel Control System: results

Informative priors:
convex combinations of Betas

Example: for fault rates [10 8 9] we used
0.01 x beta(1,1) + 0.99 x beta(1000,172.6)

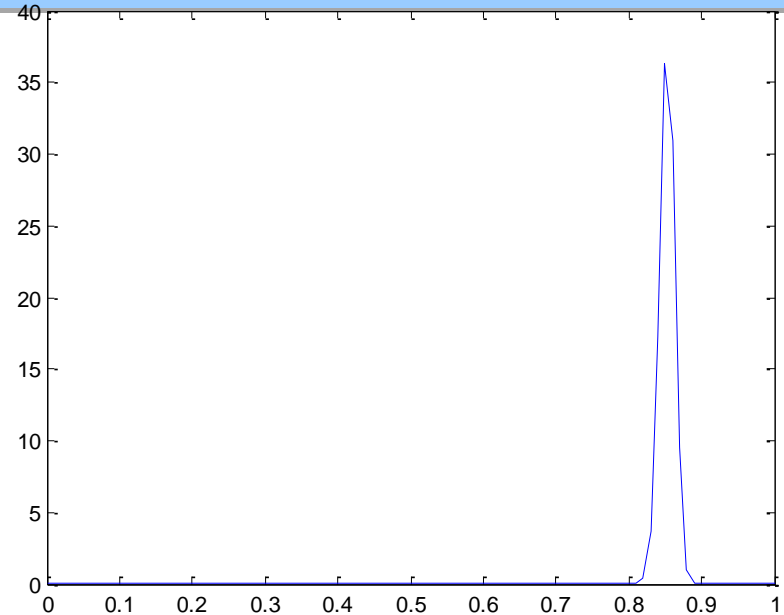

		Probability threshold θ				
		.5	.7	.8	.9	.99
Fault rates	[3 7 8]	55	12	10	8	2
	[10 8 9]	28	64	347	255	8
	[20 10 20]	8	13	20	39	1,463
	[30 30 30]	7	13	18	33	201

Fuel Control System: results

Informative priors: convex combinations of Betas

Savings with respect to uniform prior:

		Probability threshold θ				
		.5	.7	.8	.9	.99
Fault rates	[3 7 8]	55 (3)	12 (5)	10	8	2
	[10 8 9]	28 (4)	64 (31)	347 (47)	255 (455)	8
	[20 10 20]	8 (1)	13 (3)	20 (4)	39 (5)	1,463 (163)
	[30 30 30]	7 (2)	13 (3)	18 (6)	33 (11)	201 (38)

CMACS interactions

- Verification of Pancreatic Cancer models:
 - James Faeder and Haijun Gong (tomorrow)
 - Rule-based models
 - Full integration of BLTL trace verifier with BioNetGen
 - Can use Statistical Model Checking
 - Probabilistic Boolean Network models
 - Work in progress
- Atrial fibrillation (Flavio Fenton *et al.*)

CMACS interactions

- Hybrid Systems:
 - Embed BLTL checker in Simulink
 - Run-time verification (Klaus Havelund)
 - Requirements in automotive (Rance Cleveland)
 - Theory: stochastic hybrid systems (Steve Marcus)
 - Rare event simulation, nondeterminism
- Model Checking: abstraction (Patrick Cousot)
 - Speed-up simulation while preserving temporal logic properties

The End

Questions?

Bayesian Interval Estimation - I

- Estimating the (unknown) probability p that “system $\models \Phi$ ”
- Recall: system is modeled as a Bernoulli of parameter p
- Bayes' Theorem [1763] (for iid Bernoulli samples)

$$f(u \mid x_1, \dots, x_n) = \frac{f(x_1 \mid u) \cdots f(x_n \mid u)g(u)}{\int_0^1 f(x_1 \mid v) \cdots f(x_n \mid v)g(v) dv}$$

- We thus have the **posterior distribution**
- So we can use the **mean of the posterior** to estimate p
 - mean is a posterior Bayes estimator for p (it minimizes the risk over the parameter space, under a quadratic loss)

Bayesian Interval Estimation - II

- By integrating the posterior we get Bayesian intervals for p
- Fix a **coverage** $\frac{1}{2} < c < 1$. Any interval (t_0, t_1) such that

$$\int_{t_0}^{t_1} f(u \mid x_1, \dots, x_n) du = c$$

is called a **100c percent Bayesian Interval Estimate** of p

- *An optimal interval* minimizes $t_1 - t_0$: difficult in general
- Our approach:
 - fix a **half-interval width** δ
 - Continue sampling until the **posterior probability of an interval of width 2δ** containing the posterior mean **exceeds coverage c**

Bayesian Interval Estimation - III

- Computing the posterior probability of an interval is easy
- Suppose n Bernoulli samples (with $x \leq n$ successes) and prior Beta(α, β)

$$\begin{aligned} P(t_0 < p < t_1 | x_1, \dots, x_n) &= \int_{t_0}^{t_1} f(u | x_1, \dots, x_n) du \\ &= \boxed{F_{(x+\alpha, n-x+\beta)}(t_1) - F_{(x+\alpha, n-x+\beta)}(t_0)} \end{aligned}$$

- Again, no numerical integration

Bayesian Interval Estimation - IV

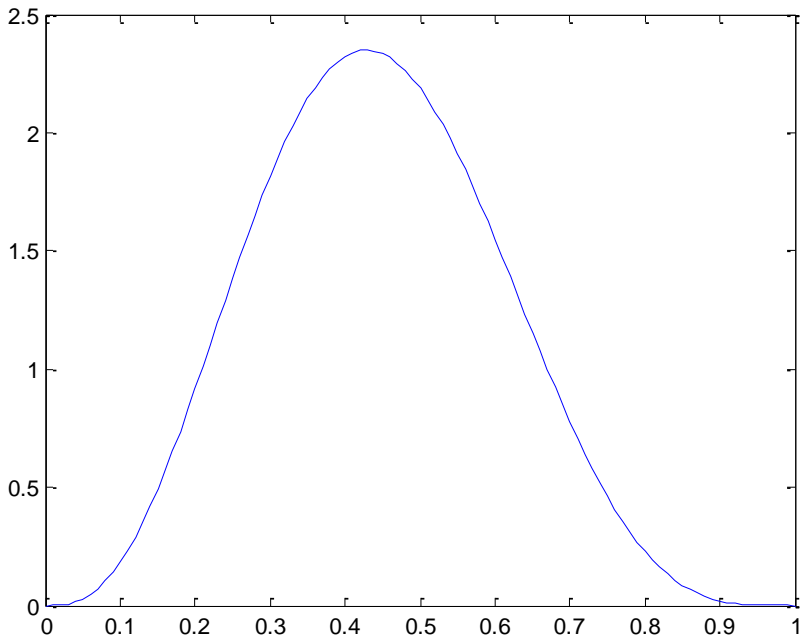

prior is $\text{beta}(\alpha=4, \beta=5)$

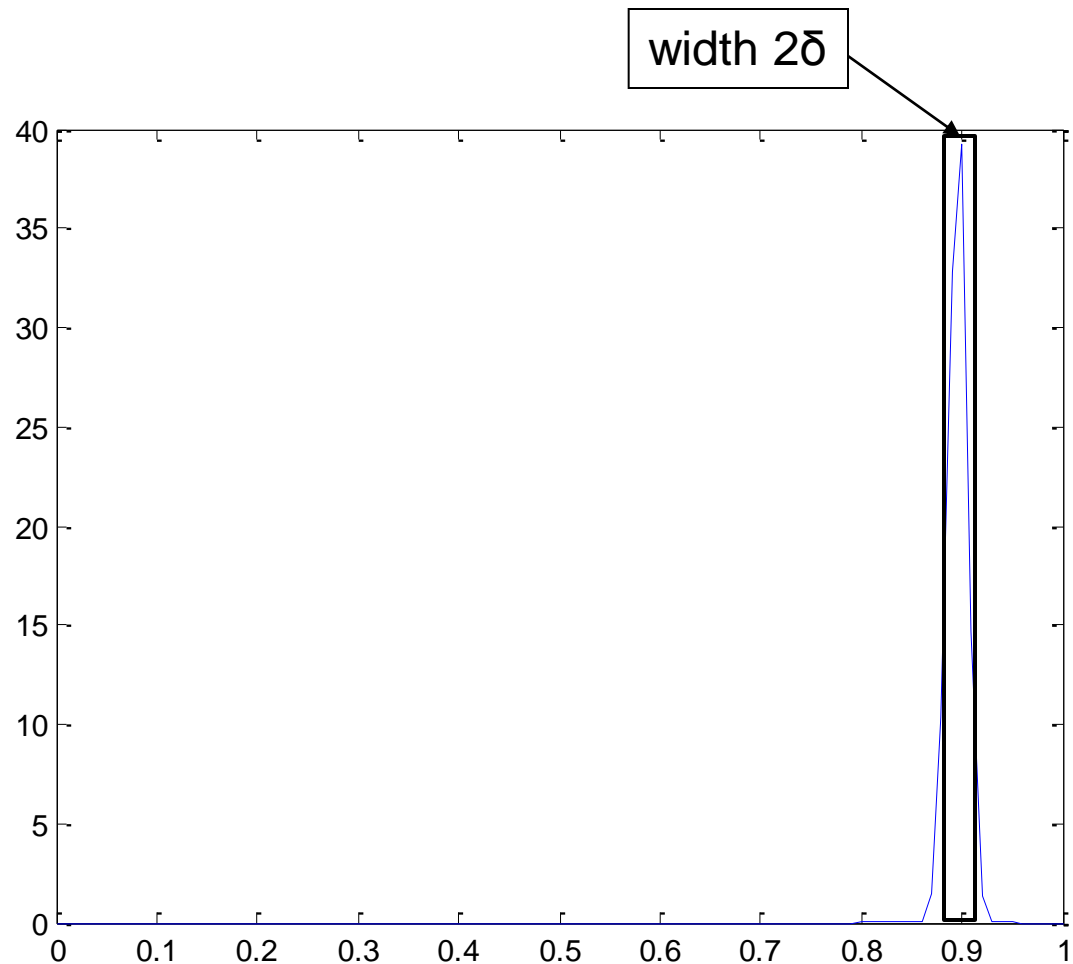

posterior density after 1000 samples and
900 "successes" is $\text{beta}(\alpha=904, \beta=105)$

posterior mean = 0.8959

Bayesian Interval Estimation - V

Require: BLTL property Φ , interval-width δ , coverage c ,

prior beta parameters α, β

$n := 0$ {number of traces drawn so far}

$s := 0$ {number of traces satisfying so far}

repeat

$\sigma :=$ draw a sample trace of the system (iid)

$n := n + 1$

if $\sigma \models \Phi$ **then**

$s := s + 1$

endif

$\text{mean} = (s + \alpha) / (s + \alpha + \beta)$

$(t_0, t_1) = (\text{mean} - d, \text{mean} + d)$

$I := \text{PosteriorProbability}(t_0, t_1, n, s, \alpha, \beta)$

until ($I > c$)

return (t_0, t_1) , mean

Bayesian Interval Estimation - VI

- Recall the algorithm outputs the interval (t_0, t_1)
- Define the null hypothesis

$$H_0: t_0 < p < t_1$$

- We can use the previous results for hypothesis testing

Theorem (Error bound). When the Bayesian estimation algorithm (using coverage $\frac{1}{2} < c < 1$) stops – we have

$$\text{Prob ("accept } H_0" \mid H_1) \leq (1/c - 1)\pi_0/(1-\pi_0)$$

$$\text{Prob ("reject } H_0" \mid H_0) \leq (1/c - 1)\pi_0/(1-\pi_0)$$

π_0 is the prior probability of H_0

Fuel Control System results: Interval estimation

- Bayesian estimation algorithm, uniform prior.

- Want to **estimate the probability** that

$$\mathcal{M}, \text{FaultRate} \models (\neg \mathbf{F}^{100} \mathbf{G}^1(\text{FuelFlowRate} = 0))$$

- For half-width $\delta=.01$ and several values of coverage c
- Posterior mean: add/subtract δ to get the Bayesian interval

		Interval coverage c			
		.9	.95	.99	.999
Fault rates	[3 7 8]	.3603	.3559	.3558	.3563
	[10 8 9]	.8534	.8518	.8528	.8534
	[20 10 20]	.9764	.9784	.9840	.9779
	[30 30 30]	.9913	.9933	.9956	.9971

Fuel Control System results: Interval estimation

- Number of samples
- Comparison with Chernoff-Hoeffding bound (Bernoulli r.v.'s)

$$\Pr (| X - p | \geq \delta) \leq \exp(-2n\delta^2)$$

where $X = 1/n \sum_i X_i$, $E[X_i]=p$

		Interval coverage c			
		.9	.95	.99	.999
Fault rates	[3 7 8]	6,234	8,802	15,205	24,830
	[10 8 9]	3,381	4,844	8,331	13,569
	[20 10 20]	592	786	1,121	2,583
	[30 30 30]	113	148	227	341
Chernoff bound		119,829	147,555	211,933	304,036

Performance of Bayesian Estimation

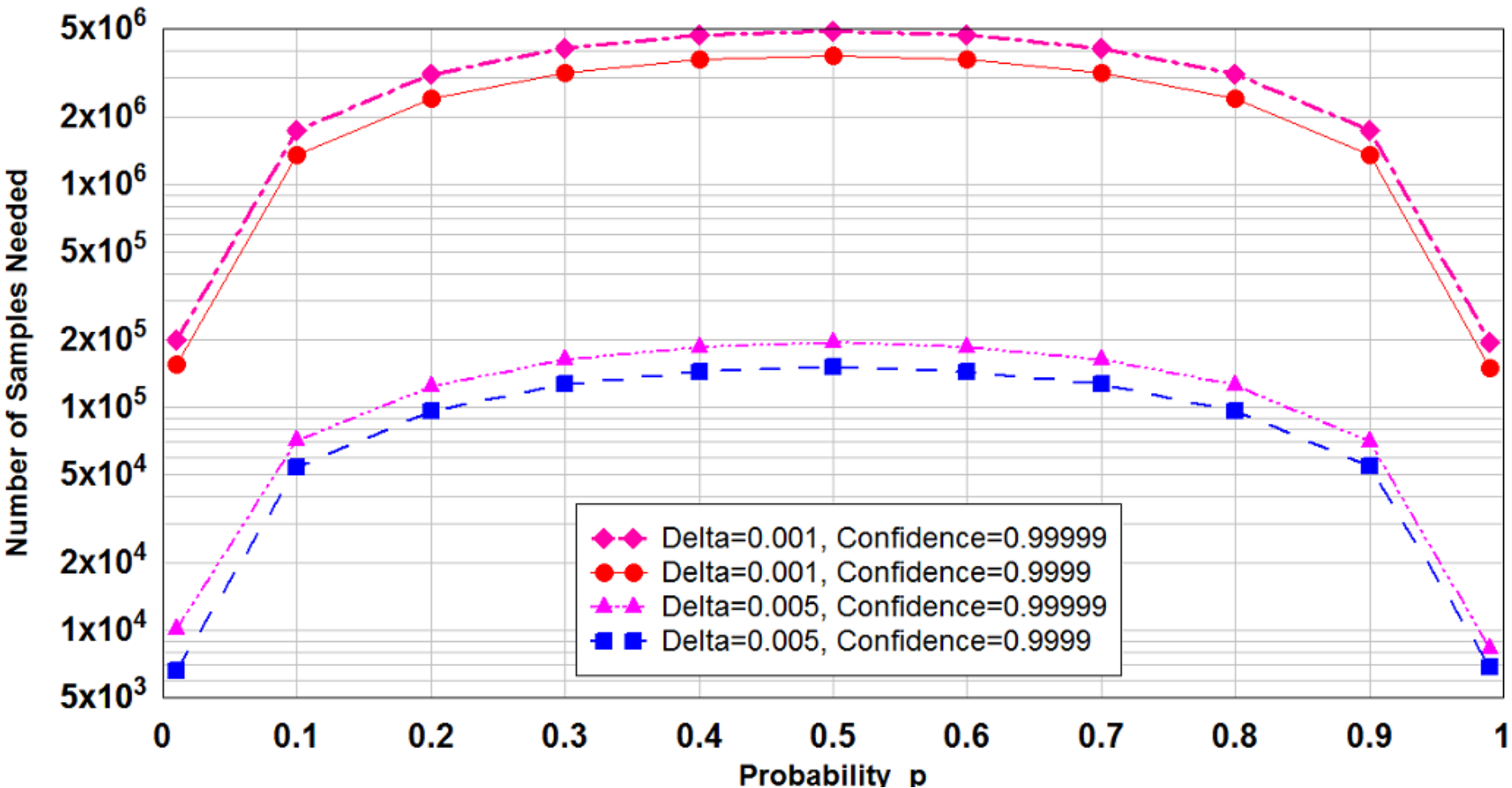

BioLab 2.0

Model Checking Biochemical Stochastic models: $\mathcal{M} \models P_{\geq \theta}(\Phi)$?

